

**NKI20/16-XL**

Needle roller bearing

Schaeffler ID:
0507620010000

Needle roller bearings NKI, light series

X-life

Technical information

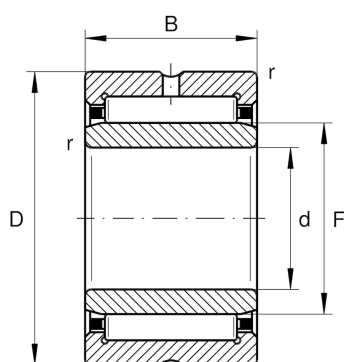
**Main Dimensions & Performance Data**

d	20 mm	Bore diameter
D	32 mm	Outside diameter
B	16 mm	Width
C_r	16,900 N	Basic dynamic load rating, radial
C_{0r}	22,300 N	Basic static load rating, radial
C_{ur}	4,200 N	Fatigue load limit, radial
n_G	18,500 1/min	Limiting speed
n_{gr}	10,100 1/min	Reference speed
	48.6 g	Weight

Dimensions

F	24 mm	Raceway diameter inner ring
r_{min}	0.3 mm	Minimum chamfer dimension
s	0.5 mm	Axial displacement

Temperature range

T_{min}	-30 °C	Operating temperature min.
T_{max}	120 °C	Operating temperature max.